

PROPRIETARY INFORMATION

THIS ENTIRE DOCUMENT AND ALL INFORMATION HEREON ARE PROPRIETARY AND THE EXCLUSIVE PROPERTY OF YANKEE HILL MACHINE COMPANY, NORTHAMPTON, MA, U.S.A. AND SHALL NOT BE REPRODUCED, DUPLICATED, OR COPIED IN WHOLE OR IN PART, OR OTHERWISE DISCLOSED OR MADE AVAILABLE TO ANY OTHER PERSON, FIRM, OR CORPORATION OR OTHERWISE USED WITHOUT THE PRIOR WRITTEN PERMISSION OF THE OWNER. THIS DRAWING OR PRINT MUST BE RETURNED TO THE OWNER UPON COMPLETION OF THE PURPOSE FOR WHICH IT WAS RELEASED BY YANKEE HILL MACHINE COMPANY, NORTHAMPTON, MA, U.S.A. OR EARLIER UPON DEMAND OF THE OWNER.

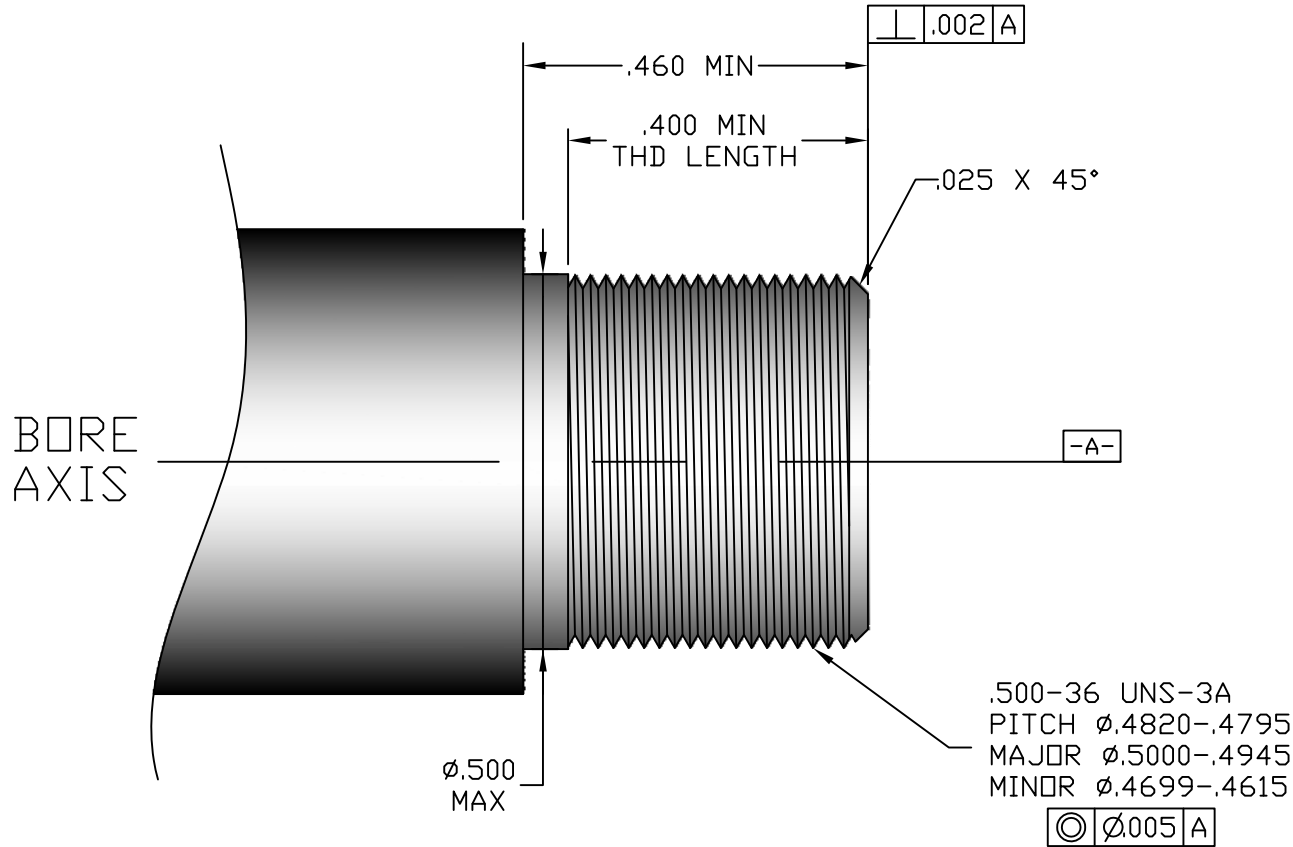

Yankee Hill Machine, Inc. 

UNLESS OTHERWISE SPECIFIED	DVS REVISIONS				DESCRIPTION			
	LET.	DATE	BY	APPD BY				
B/E .005 MAX					.500-36 UNS-3A COBRA M2, UNIVERSAL THREAD ADAPTER			
FIL R. .015 MAX								
TOL ± .005								
SURF. FIN. 125 ✓								
ANGLES ± 2°								
					STEP	DP	PART NUMBER	
					THREAD SPEC			
					DRAWN BY	DATE		SHT. OF

NOTES:

1) ALL DIMS CONCENTRIC WITHIN .003 T.I.R.